

# Panel Brackets / Panel Mounting Screws

Steel, Stainless Steel

## Panel Brackets Steel, Stainless Steel

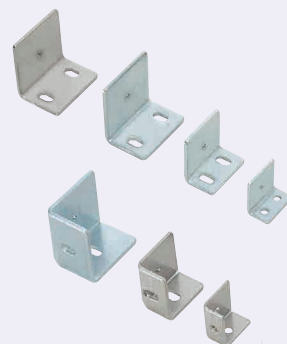

Type	Material	Surface Treatment
Steel Type	SPCC	Trivalent Chromate
Stainless Steel Type	SUS304	-

### For Middle Mounting

Steel Type **HCBV5**  
Stainless Steel Type **SHCBV5**

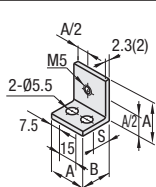

Steel Type **HCBV6**  
**HCBV8**  
**HCBV8-45**  
Stainless Steel Type **SHCBV6**  
**SHCBV8**  
**SHCBV8-45**

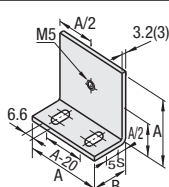

### For Corner Mounting

Steel Type **HCBCV5**  
Stainless Steel Type **SHCBCV5**

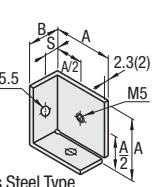

Steel Type **HCBCV6**  
**HCBCV8**  
**HCBCV8-45**  
Stainless Steel Type **SHCBCV6**  
**SHCBCV8**  
**SHCBCV8-45**

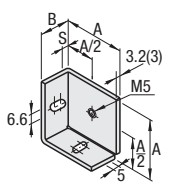

The values in ( ) are for Stainless Steel Type.  
So as to enhance reinforcement, the plate attachment hole height A/2 differs from that of Aluminum Type and Plastic Type.



Two methods of panel mounting are available for No. 6, 8 and 8-45 of Steel Type and Stainless Type (5mm thick or less) since these products have slotted holes.

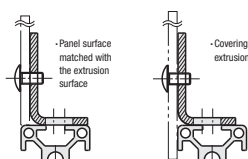

### Steel Type

Part Number	Mass	Difference between the Extrusion Side and Attachment Face	S	A	B	Screw, Nut		HCBV	HCBCV		
						Screw	Nut	Unit Price	Volume Discount Rate		
HCBV	5	29	23	0	10	30	18	CBM5-8	HNTT5-5		
HCBCV	6	79	60	0-5	40	25	2	CBM6-12	HNTT6-6	2	
	8	124	94	(Variable)	15	50	35	CBM6-15	HNTT8-6		
	8-45				17.5	50	35	CBM6-15	HNTT8-6		

### Stainless Steel Type

Part Number	Mass	Difference between the Extrusion Side and Attachment Face	S	A	B	Screw, Nut		SHCBV	SHCBCV		
						Screw	Nut	Unit Price	Volume Discount Rate		
SHCBV	5	23	18.5	0	30	18	2	SCB5-6	HNTTSN5-5		
SHCBCV	6	62.5	50	0-5	40	25	2	SCB6-10	HNTTSN6-6	2	
	8	113	85.5	(Variable)	15	50	35	SCB6-15	HNTTSN8-6		
	8-45				17.5	50	35	SCB6-15	HNTTSN8-6		

Ordering Example  
Part Number - Length  
**HCBV6** - **1000**  
**SHCBCV8** - **1000**

Alterations  
Part Number - (SET)  
**HCBV6** - **SET**

Alteration	Code	Spec.	Bracket	Screw, Nut			
				For Extrusion Fitting		For Panel Fitting	
				Screw	Quantity	Nut	Quantity
Applicable Screw and Nut Set	SET	Applicable screws and nuts come in a set.	HCBV5	CBM5-8		HNTT5-5	
			HCBV5	CBM5-8		HNTT5-5	
			HCBV6	CBM6-12		HNTT6-6	
			HCBV6	CBM6-12		HNTT6-6	
			HCBV8	CBM6-15		HNTT8-6	
			HCBV8-45	CBM6-15		HNTT8-6	
			HCBV8	CBM6-15		HNTT8-6	
			HCBV8-45	CBM6-15		HNTT8-6	
			SHCBCV5	SCB5-6	2	HNTTSN5-5	2
			SHCBCV5	SCB5-6	2	HNTTSN5-5	2
SHCBCV6	SCB6-10		HNTTSN6-6				
SHCBCV6	SCB6-10		HNTTSN6-6				
SHCBCV8	SCB6-15		HNTTSN8-6				
SHCBCV8-45	SCB6-15		HNTTSN8-6				
SHCBCV8	SCB6-15		HNTTSN8-6				
SHCBCV8-45	SCB6-15		HNTTSN8-6				

## Panel Mounting Screws



Part Numbers shaded are not RoHS compliant.

**HCBM**  
**SHCBM** (Stainless Steel)  
**HCBMB** (Trivalent Chromate, Black)

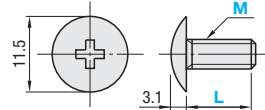

Type	Material	Surface Treatment
HCBM	Carbon Steel for Mechanical Structure	Bright Chromate Plating
SHCBM	SUS304 Equivalent	-
HCBMB	Carbon Steel for Mechanical Structure	Trivalent Chromate (Black)

Part Number	Length	HCBM		SHCBM		HCBMB	
		Unit Price	Volume Discount Rate	Unit Price	Volume Discount Rate	Unit Price	Volume Discount Rate
HCBM	10	1-79 pc(s)	80-99	100-200	1-79 pc(s)	80-99	100-200
SHCBM	12	1-79 pc(s)	80-99	100-200	1-79 pc(s)	80-99	100-200
HCBMB	15	1-79 pc(s)	80-99	100-200	1-79 pc(s)	80-99	100-200

L Dimension 15 is for HCBM. For other screws, see P751.

For HCBM, SHCBM and HCBMB, package sales (500 pieces per package) are available for each size.

M-L	HCBM	SHCBM	HCBMB
5-10	Set of 500 pcs. (SET1)	Set of 500 pcs. (SET1)	Set of 500 pcs. (SET1)
5-12			
5-15			

When ordering, please note the quantity. 500 pcs. will be delivered for HCBM5-10-SET1 order.

Ordering Example  
Part Number - L  
**HCBM5** - **10**

Part Number - L - SET1  
**HCBM5** - **10** - **SET1** (500 pcs.)

# Slide Rails / Slide Spacers

Plastic Type

## Slide Rails



**HRLFLJ2**  
(For 2 Rows of 5mm Thick Plate)

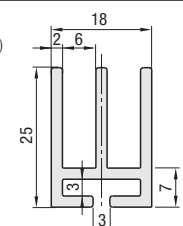

**HRLFLJ3**  
(For 3 Rows of 5mm Thick Plate)

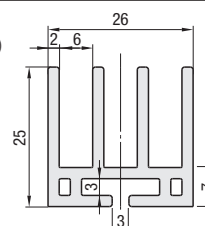

Use the Slide Rail Connectors to connect the Slide Rail to Aluminum Extrusions.

Material: ABS Resin (Light Gray)

Part Number	Length	Extrusion (Series)	Mass kg/m	Unit Price/m
HRLFLJ	50-2000	HF55	0.185	
		HF56		
		HF58(-45)	0.277	

## Slide Rail Connectors



**HRLCN5**

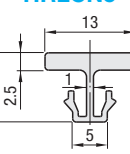

**HRLCN6**

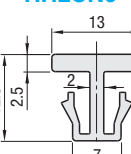

**HRLCN8**

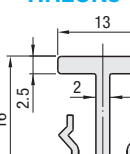

Used to connect the Slide Rails to the Aluminum Extrusions.

Material: Polypropylene (Light Gray)

Part Number	Length	Extrusion (Series)	Mass kg/m	Unit Price/m
HRLCN	50-2000	HF55	0.045	
		HF56	0.064	
		HF58(-45)	0.072	

Ordering Example  
Part Number - Length  
**HRLFLJ3** - **1000**  
**HRLCN6** - **1000**



Connection with Extrusion

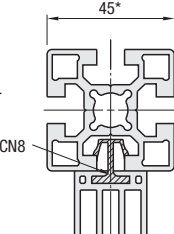
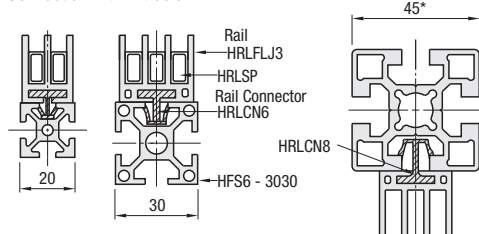

\*Also use HRLCN8 for HFS8-50 and HFS8-60.

Select HRLFLJ3 and HRLCN6 in order to attach 3-rows rail to the frames of HFS6 Series.

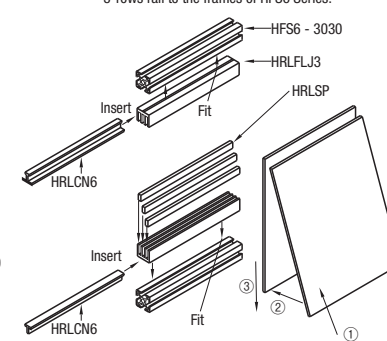

Post-assembly Side View

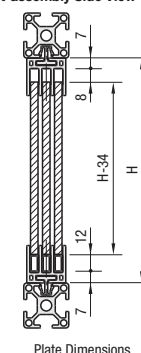
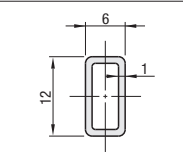

Plate Dimensions

## Slide Spacers



**HRLSP**



Type	Material	Heat Resistance Temperature
HRLSP	Polyethylene (Black)	-45 ~ 80°C

RoHS 10

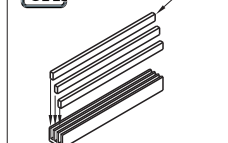

To be inserted into the lower rows of Slide Rails  
Can be cut with scissors or a utility knife.

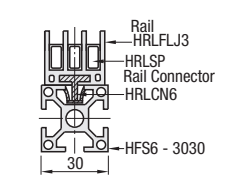

Part Number	Length mm	Unit Price	Volume Discount Rate	Part Number	Length mm	Unit Price (Set of 30 pcs.)
HRLSP	2000	1 ~ 9 pc(s)	10-50	HRLSP-SET	2000	
				(Set of 30 pcs.)		

Ordering Example  
Part Number  
**HRLSP**  
**HRLSP-SET**